



STONE FACTS





When it comes to purchasing stone, you need all of the facts & figures to select the right material for your project. Take advantage of this guide, which provides you with all of the stone facts, terminology, and information you need to get started!

1. [Stone Terminology](#)
2. [Basic Stone Finishes](#)
3. [Chopped and Chiseled](#)
4. [Banding and Wall Cladding](#)
5. [Smooth Cut Applications](#)
6. [Keystones](#)
7. [Header Styles](#)
8. [Headers Shapes](#)
9. [Moldings](#)
10. [Coping and Caps](#)
11. [Watertables, Sills and Bands](#)
12. [Watertables and Sills](#)
13. [Bevels](#)
14. [Quoin Corners](#)
15. [Ledgestone](#)
16. [Thin Veneer](#)
17. [Thin Veneer Installation](#)
18. [Fireplace and Surrounds](#)
19. [Address and Name Blocks](#)
20. [Packaging and Delivery](#)

TERMINOLOGY

Full Veneer Stone is approximately 4" thick, with 1/2" either + or -. This stone fits perfectly on a standard brick ledge. The larger the stone, such as 10" or more, may be thicker due to the nature of the stone. Full Veneer stone can be cut any size from 4" to 10" on most colors of stone. Rust stone can be cut up to 24" tall. Random lengths are generally from 12" to 24" long.

Quality Stone has standard colors: White, Cream, Rust, Grey, Caramel, and Sandstone. We also have many mixes and blends for a wide variety of color to compliment any decor.

Quality Stone Thin Veneer is the same as Quality Stone full veneer only thinner! Thin Veneer, called "flats" are 1-1/4" to 1-1/2" thick. We have thin veneer in two chop stone categories. We have "10's" down", which means you will receive a nice variety of all sizes from 2" to 10". We also have specific sizes that come in 4", 6" 8" and 10" only. Thin Veneer flats are priced by the sq.ft and corners in 4", 6" & 8" to match, are sold by the linear foot.

Ledgestone is "5's" down" tall pieces of stone that are stacked on top of each other to give a non-mortared look. The Lee Valley Blend is a sawed top and bottom version of ledgestone with all the pieces being very close in size. Ledgestone is available in Full and Thin Veneer.

Renaissance stone is smaller pieces of random sized stone that are set very close together for a renaissance style old world look.

Flagstone is natural shaped colored stone that ranges in thickness from 3" to 5". Also called Flaggon or Builders. Commonly used for housing stone, porched and patio application.

Natural Patio is the same as Flagstone, except it is 1" to 3" thick. This stone is used for patios, garden paths and porches.

Diamond Sawed Patio is cut smooth on top and bottom. The slabs are generally 22" wide x 5' long and our standard thicknesses are 1-1/4" and 2-1/4". Other sizes are available. This stone is wonderful for walkways, caps, decorative pieces and wall cladding. The standard colors are white, cream and gray. We also have caramel and sandstone.

Drystack stone is used for decorative borders and retaining walls. The thicker stone is perfect when mortar or non-mortar application is needed. This stone can be cut in many popular sizes from 6"x 6" to 8" x 12".

Split-face Chop is flagstone that is chopped to make straighter edges forming close to square or rectangular shapes.

Natural Boulders are naturally shaped stone ranging in thickness from 6" to 12". These stones can range from 100 to 1000 pounds.

Quarry Blocks are 22" tall x 24" wide and approx. 5' long. These are terrific for retaining walls. The average weight is 2700 pounds per block.

Special Cuts will be priced according to size, color, difficulty of cut surface and amount of stone needed. Most special cuts are priced by the linear or square foot, depending on the stone. Special cuts will include, but not limited to: caps, keystones, watertables, window sills, lentils, mantles, hearths, tile, wall cladding and counter tops, to name a few. Submit a cut list for faster estimates.

Sawed Stone has been sawed in the quarry and may have saw marks on the stone. Lightly Sanded is stone that has a light sanding to remove most of the saw marks. Honed Stone has been sanded to a smooth finish.

Polished Stone is a very smooth, shiny surface that can be applied on some of our stone. Grey and white are the best stone for polishing. Most white stones can be polished, but some do not get as shiny as the grey. Cream does not polish well. There are many steps in the process of stone polishing. Please allow extra time and cost for polishing.

Fireplace and Fireplace Surrounds must have a cut list for cost estimations. A homeowner may want to add a hand drawing, with dimensions added, for clarifications.

Please specify not only quantity but also color choices and finishes-such as smooth, chopped, chiseled, honed etc. when asking for a quote.



Smooth Cut Stone

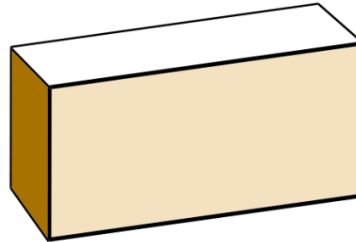

Chopped Face Stone

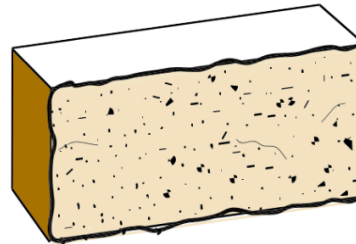

Chisel Faced Stone

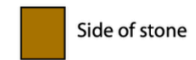
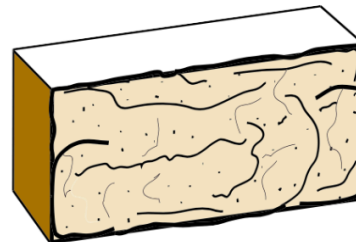

Smooth Cut Stone

Chopped stone has been chopped to size from larger blocks of stone. Our measurements always state the face height first. The thickness is 4" + or- 1/2". Larger sizes may be thicker due to the size of the stone. Chopped stone is used for housing wall veneer, fireplaces, landscaping and many other decorative usages. Depending on the color and sizes you chose, chopped stone is available in many sizes.

Most commonly used (face) sizes are 4", 6", 8" and/or 10". A few colors can be as tall as 24". An ashlar pattern is usually a nice variety of sizes from 2" to 8" or 10". You can also chose to do courses, in which all the stone in a row is the same height. All chopped stone comes in random lengths from 12 to 24" long.

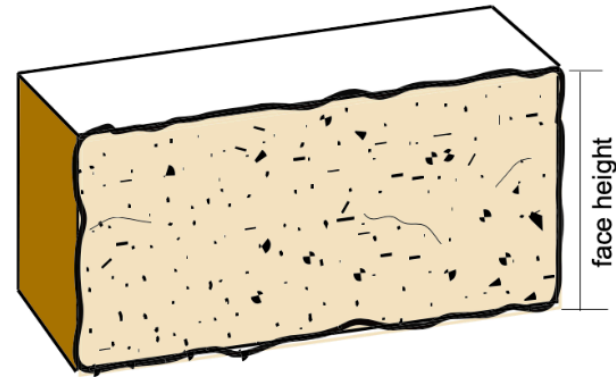

Chiseled Stone

Hand Chiseled stone is used for cut stone when the customer would like to have precise sizes on all 6 sides, but wants a non-smooth surface on the front and/or sides, such as a mantle or hearth front.

Other uses for hand chiseled stone are window sills, lentils caps, tables and benches, to name a few.

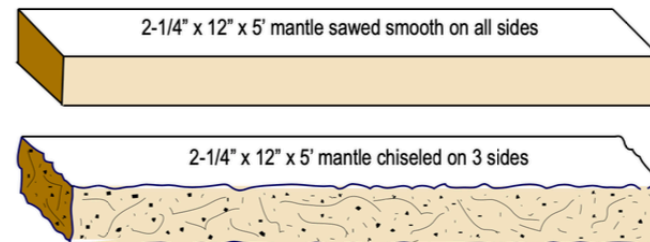

Banding

Banding is a decorative band that is included in the design of the wall stone. The standard thicknesses are 1-1/4", 2-1/4" or 4".

Generally the banding is 4" tall, with random lengths. The banding can be chopped, smooth, chiseled and beveled several different ways.

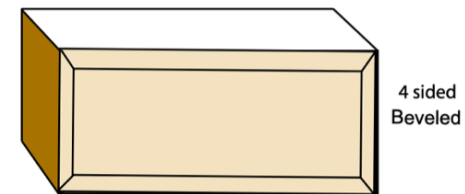
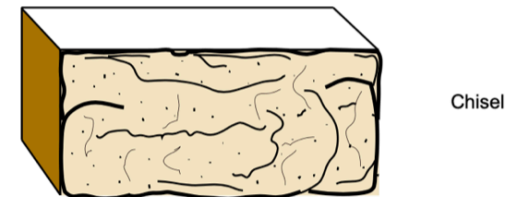
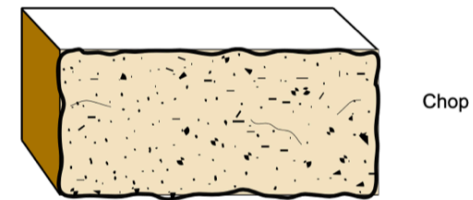
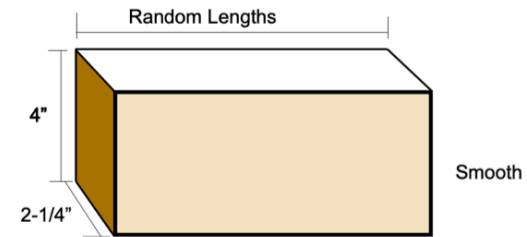

Wall Cladding

Wall Cladding is available in the same thicknesses as the banding. The height can be 4", 6", 8", 10" or 12" with random lengths.

Chiseled stone is only available up to 8".

Smooth cut stone is stone that has been sawed with a diamond bladed saw. It could possibly have saw marks, like swirls, on the surface.

Lightly Sanded

Stone that has been sanded just enough to remove the saw marks.

Honed Stoned

Stone that has been sanded by hand enough to take out any swirl marks.

Polished Stone

Polished stone has been hand sanded a number of times with different types of polishing grits to a very smooth, glossy or semi-glossy finish.

Please note that some stone, such as the cream, does not get a glossy finish.

Applications

Smooth stone can be cut into many shapes and sizes, such as:

- Mantles
- Hearths
- Lentils
- Sills
- Water Tables
- Address Blocks
- Tile
- Counter Tops
- Cap Rocks
- Table & Bench Tops
- Wall Cladding
- Walk Ways
- Any where a flat smooth surface is desired

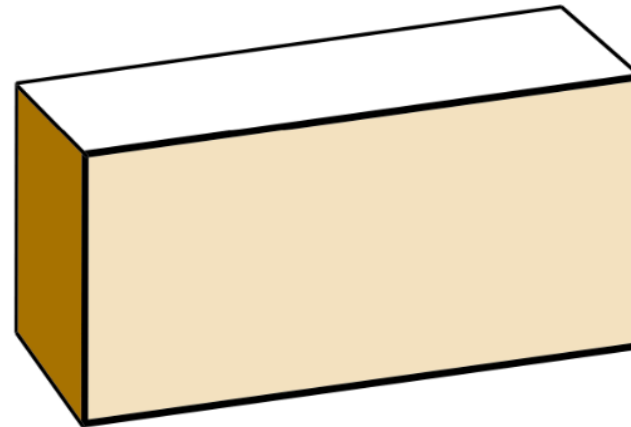

Keystones

Keystone are custom cut stones that add architectural detail to any building. Keystones are available in smooth and with beveled edges. They can be any size to meet your design needs.

Keystones that are set above a window or door, with companion lentils add a dramatic finish to any design. Keystones and companion lentils can be cut to match any decor specifications.



Smooth Keystone

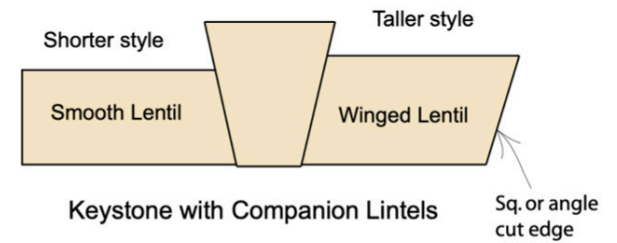

Keystone with Companion Lentils

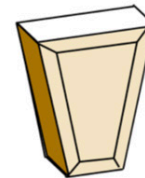

Beveled Keystone

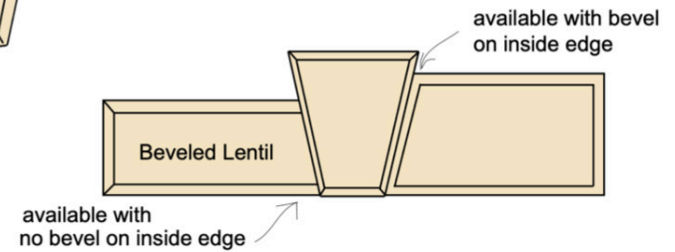

Keystone with Companion Lentils



Headers

We offer 3" H x 4" W and 4" H x 8" W with random lengths, up to 2' as our standard sizes. Other sizes available as special order items.

White, Cream and Grey are standard colors. Other colors are available.

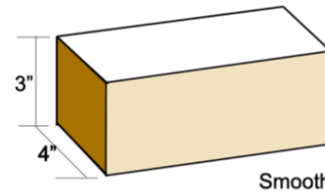

Smooth

Smooth stone is available in White, Cream, & Gray.

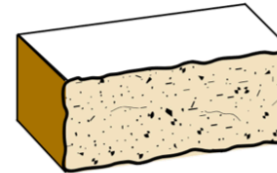

Chopped

Chopped stone is available in White, Cream, Rust, Gray, & Caramel.

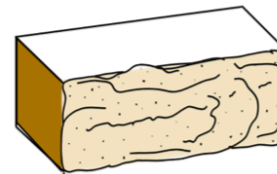

Chiseled

Chiseled stone is available up to 8" only and available in White, Cream, & Grey, Caramel.

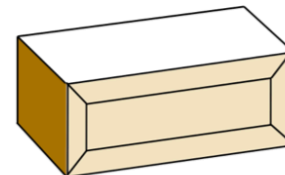

Beveled

Beveled stone is available in White, Cream, Gray, & Caramel.



Front View

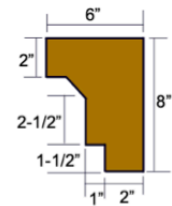
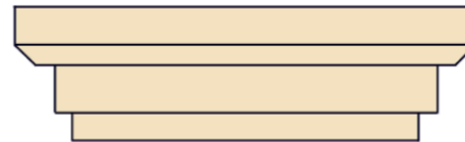

Headers can be cut into many different shapes to fit the need of your project.

Left Return

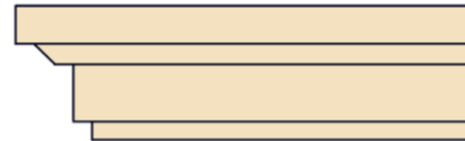

Right Return

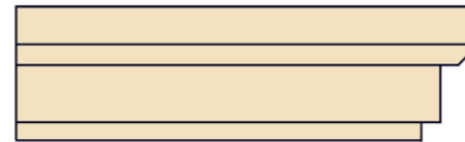

Side View of Stone Molding Cuts

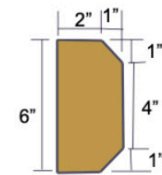
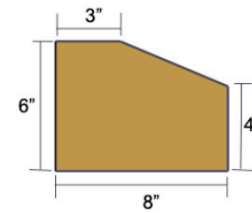

Molding

Molding can be cut to your specifications. These are just a few samples of the different shapes that we can make. We can cut molding in White, Cream or Grey in up to 24" lengths.

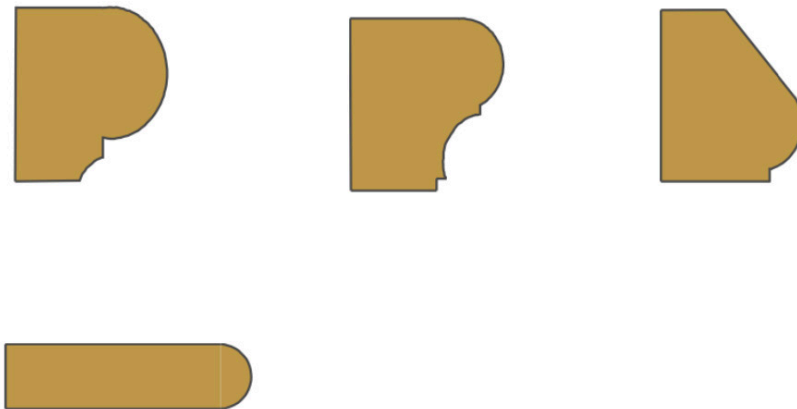

End Elevations

Pyramid Style

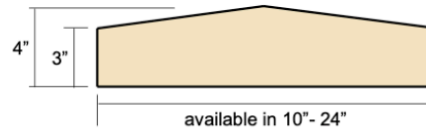

Sloped Style

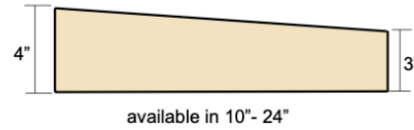

Straight Cut Style



available in 2-1/4" - 4" heights
available in 10" - 24" widths
available up to 4 ft. lengths

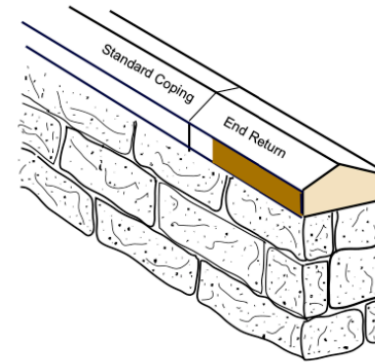

Example of coping on a wall

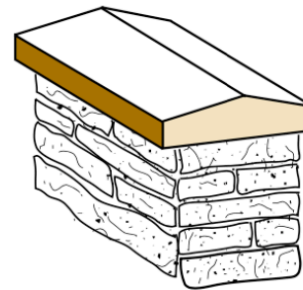

Example of a cap



Standard sizes for watertables, sills and bands is 3" x 6" or 4" x 8". All other sizes shown below are special order.

The samples here show some of the basic shapes of the watertable and bands that are available. We can produce other sizes, shapes and measurements upon request as a special order item. Most of the sizes above are available in 24" lengths.

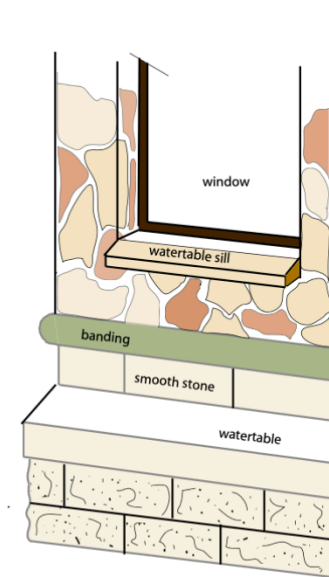
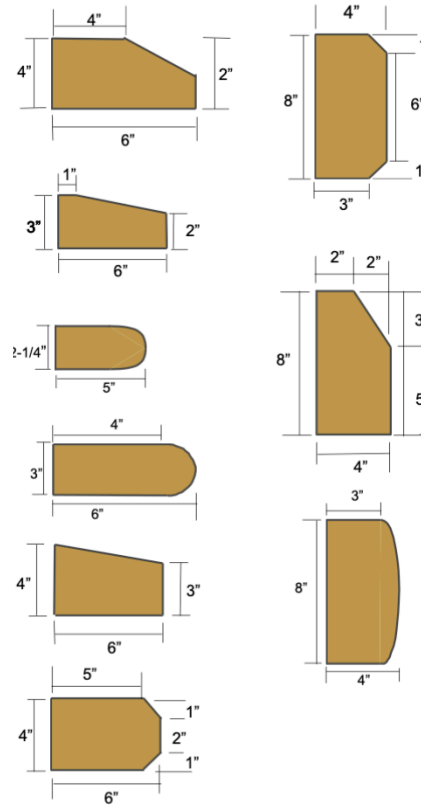

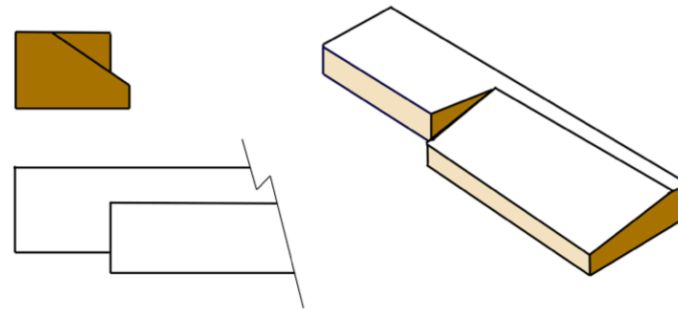

Example of a 4" x 6" Left Return Watertable

The standard sizes that we use for watertables and sills is 3" x 6" and 4" x 6". Other sizes will be made as a special order item. Available in White, Cream and Grey. Up to 24" lengths are standard.

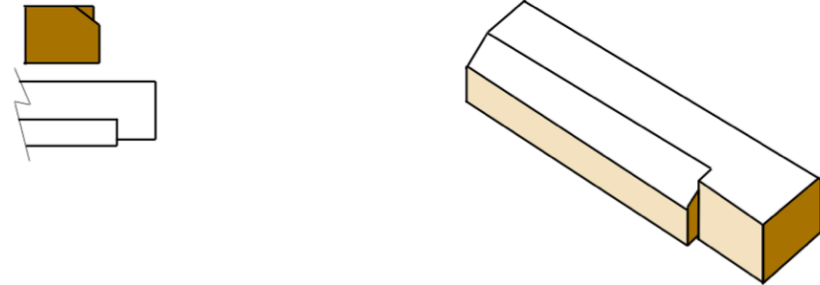

Example of 3" X 4" Right Return Watertable

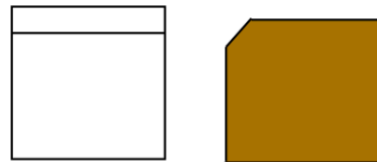

Single top bevel

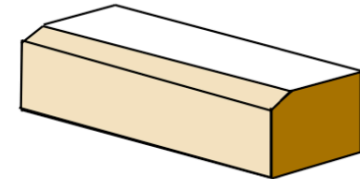

Bevels (also called Chamfers) can be on one side, two sides or all four sides of a stone. This detail can be used in many places in your design to add a classic touch.

You can chose the size of the bevel to suit your usage.

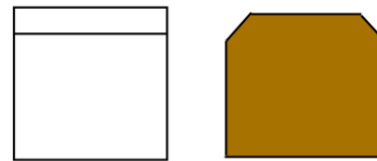

Double sided top bevel

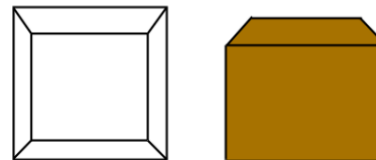
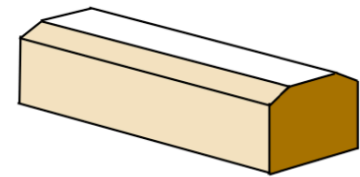

Four sided top bevel

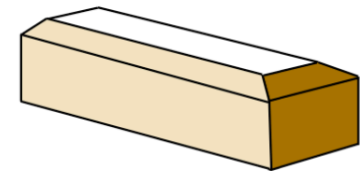

Quoin Corners add a beautiful accent to the corner of any wall. Usually a different size, color and texture, the quoin corner will definitely add “pop” to your architectural design. Most Quoin Corners are smooth and sometimes stand out from stone 1/2” to further increase the design aspect. Speak to your builders about adding these lovely quoin corners to your design plan.

These are special cuts, so allow extra time for the cutting.

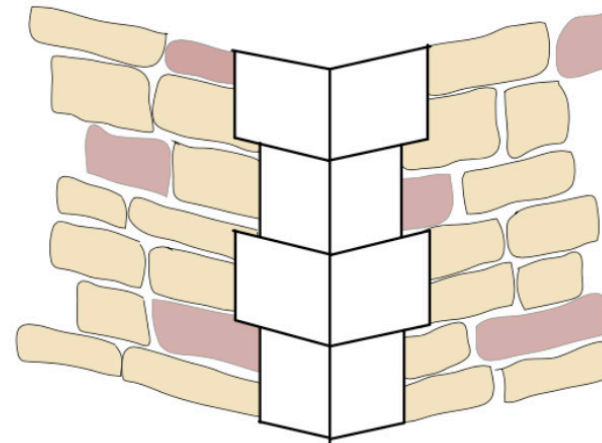
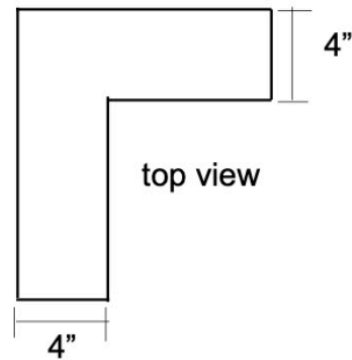

Ledgestone is a stacking of small thin pieces. These pieces are generally no taller than 5-6" They are a natural stone, such as a flagstone, cut into short thicknesses. The full veneer will be 4-5" thick and the thin veneer will be 1-3" thick. This stone will come in natural earthy tones with no choice in color.

The ledgestone will have natural edges for a more primitive look.

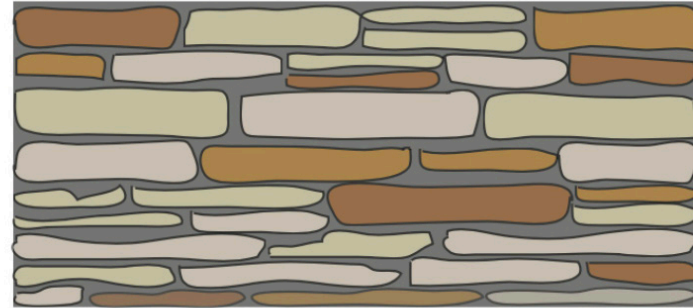

Lee Valley Blend

Another style of ledgestone is our Lee Valley Blend. This lovely pattern is sawed top and bottom for a clean drystack look. Lee Valley comes in two color choices: Lee Valley original and Lee Valley Cream.

The original Lee Valley look is 2", 3" and 4".

The Lee Valley look is available in sizes several sizes, and the customer may choose the sizes from 6" and down.



Thin Veneer stone in chopped rock, ranges between 1-1/4" and 1-1/2" thick.

The chopped stone is divided into 2 size categories. The standard height sizes for the flats are 4", 6" and 8". With this selection you may chose 4" or 6" or 8" or some of each size.

We also carry a random height size from 2" to 10". With this selection, you will get a nice variety of all the sizes from 2" to 10", with no choice of sizes, odd sizes included. Corners will match the chopped stone thin veneer that you chose, in sizes 4-6-8" only.

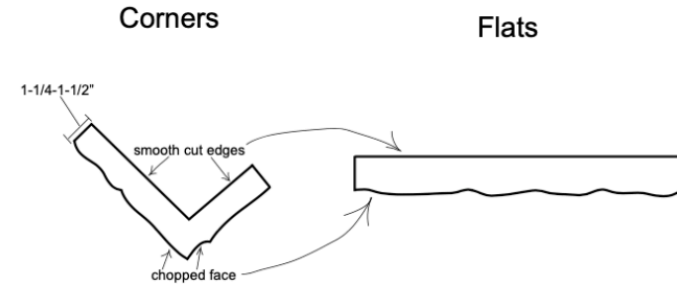

Flagstone Thing Veneer

Flagstone thin veneer is random sized pieces that are put together like puzzle pieces. The stone will not be over 12" high at the tallest point. Flagstone does not have corner pieces, so your mason will randomly overlap pieces at the corners.

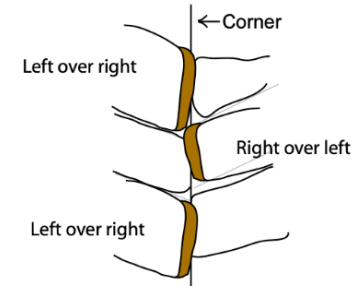
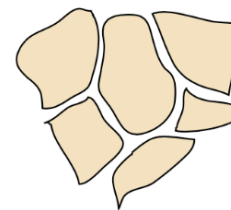



BACK WALL SURFACE	EXAMPLES	INTERIOR & EXTERIOR PREPARATION
Ridge Black Wall	Concrete Board, Paneling, Plywood Wallboard 7 Wall Sheathing	Cover sheathing and other surfaces with a breather type weather resistant barrier, lapping joints 4 inches. Install and lap metal lath or mesh in accordance with local building codes. Secure metal lath or mesh using galvanized nails or staples on 6" vertical centers. Weather resistant barrier and metal lath should extend a minimum of 18" inside or outside corners and continuously cover all surface areas.
Clean & Untreated	Concrete, Masonry & Stucco	No preparation is needed. If newly poured concrete or recently installed masonry have a finished surface that contains a releasing agent, etch surface with muriatic acid, rinse thoroughly, and rough with wire brush.
Dirty, Painted & Sealed	Concrete	Sandblast to original surface and wash thoroughly or securely attach metal lath.
Metal Buildings		Install and lap paperbacked 3/8" rib expanded metal lath to metal cladding supports of 20 gauge to 12 gauge. Use 1-1/4" type S-12 Pancake Head Super Tite screws. Screws must penetrate 3/8" beyond the inside face of the metal surface. Screws are to be installed on centers equal to 1 screw per sq.ft. and not exceed 6" on center in one direction. Apply 1/2" to 3/4" scratch coat and allow to dry for 48 hours.



When your stone arrives on the job-site, unpack all of the Quality Thin Stone Veneer to ensure materials have arrived safely. It is best to combine stone from each pallet to ensure a good range in color and sizes as the stone is being applied to your surface. Material mixing is a great way to encourage the use of small material next to larger pieces, rough next to smoother and dark next to light.

The combination of these stone characteristics will help achieve the most desired results.

Because thin veneer stone is smooth on the back, you must apply mortar to the back of each stone and the wall surface to make sure there is good adhesive between the two.

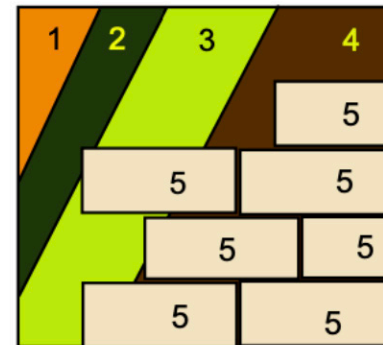

1. Surface to be covered
2. Construction paper
3. Metal Lath
4. Setting Mix
5. Quality Thin Stone Veneer

Standard mantles can be made in sizes of 2-1/4" , 3" and 4" thick. The normal width is 10" to 12" and 4 to 5 foot in length.
We will cut other sizes upon request.

You can choose the mantle, mantle and hearth, a mantle with supports or braces, like the headers. You can also have a full surround which would include the sides or legs, hearth and a hearth base.

Side view of Mantle and Support

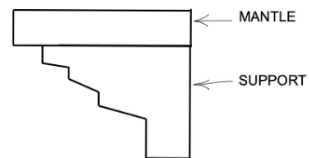

Front View of Fireplace Surround

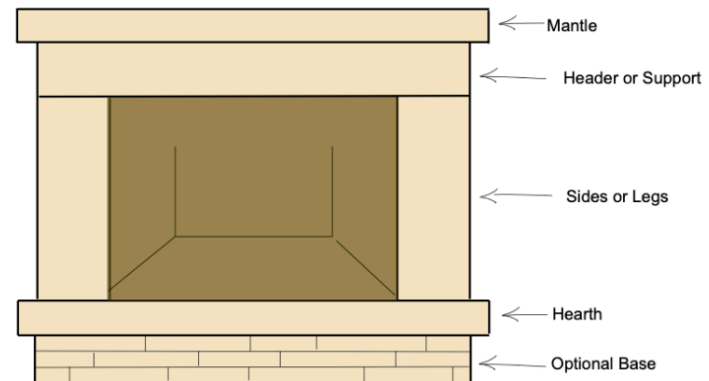



The standard size for rectangle address or name blocks is 8" x 12", 8" x 15" and 12" x 15". Other sizes and styles are available by special order. Standard stone colors are white and cream. We also have grey available. The blocks are top sanded smooth and can be polished upon request. An intricate design may require a polished stone.

The standard thicknesses are 2-1/4" for decorative use and 4" to be added to a wall during the installation of your stone.

Artwork is an additional charge, based on time, difficulty and original artwork, if provided or required. Any silhouette that is in our library will be added for free.

The state of Texas address stone is available in white or cream in a 10" or 14" size. Color added to font/artwork will include one color of your choice. The choice of font is totally up to the customer. We have a very large selection, but if you chose one that we do not have, you will need to provide it or choose a different style.

When you have placed an order for an address or name block and have not supplied the exact font you want, we will supply a few samples for you to choose from. We will also require a signature of approval along with down payment before work begins. Please double check for correct spelling.

Unless otherwise requested, we will leave at least 1" space around the numbers or words. The samples below show an 8" x 15" block. As you can see, the more numbers and words reduce the sizes. With 2 lines the numbers are indented 2" on each side for visual appeal. Vertical applications are available, but limit the amount of characters that will fit and numbers will be smaller: 6" numbers on left sample vs 3" numbers on right sample.

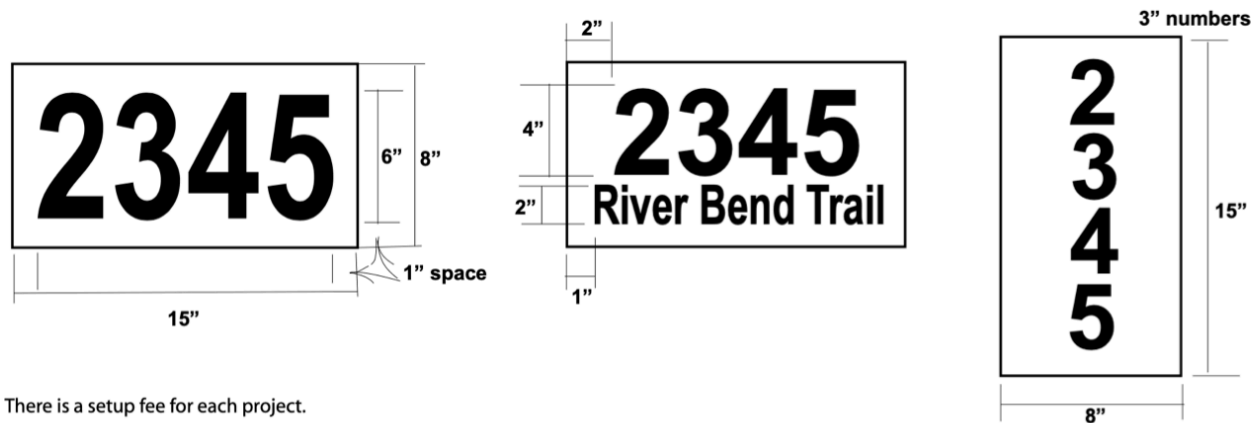

There is a setup fee for each project.



Packaging

The stone supplier and the customer should always agree upon packaging and crating arrangements prior to shipment leaving the quarry. Standard packaging of Quality Stone Thin Veneer consists of stone stacked on pallets and wrapped with chicken wire or plastic to contain the stone during loading, unloading and transport. Standard pallet will be 1 ton and cover 175 sq.ft.

Standard packaging for Quality Stone Full Veneer on pallets, consists of chopped stone on pallets and wrapped in plastic. Pallets generally weigh 1-1/2 ton unless smaller pallets are requested.

Standard packaging for Quality Stone Special Cuts consists of stone stacked on pallets with Styrofoam sheeting placed between each stone and then banded. Standard packaging for Quality Stone Diamond Sawed Patio will be 1 ton (8 slabs) of 2-1/4" stone slabs placed together on a pallet and banded. We also make 1-1/2 tons (12 slabs) pallets.

Additional packaging may be required, depending on the type of stone, mode of transportation, distance of delivery and other circumstances. Any additional packaging requirements needed to protect the stone will be at the customers' expense. Please remember that no matter how well something is packaged, human error can cause stone to break. Inspect all deliveries and do NOT sign a delivery ticket until you verify that the delivered materials have arrived safely.

Delivery

Quality Stone's first choice in delivery, whenever possible, will be Flatbed "Over the Road" Trucks (OTR) for delivery of your stone because these trucks have air ride and once the load has been placed on the truck it will be delivered directly to your job site. LTL (Less than Truckload) carriers used for smaller deliveries do not have the same air ride. These trucks may load and unload your order several times before it gets to the job site, which means there is a greater chance of breakage. Any stone delivered by LTL will be the customers' responsibility.

Quality Stone recommends using the flatbed trucks for delivery, even if there is a slightly higher cost, to ensure the safety of your delivery. A flatbed is desirable for delivering stone in a smaller space where dumping is not an option. There must be a machine on site to off-load the pallets. All loads going out of Texas must be on a flatbed with palletized stone.

The choice between OTR or LTL is entirely the customers and we will ship the stone however the customer would prefer. The customer also has a choice to pick up their stone, hire their own truck or have Quality Stone arrange the freight delivery. If the customer chooses to have Quality Stone arrange the freight delivery, payment for the delivery must be paid in advance of the stone being picked up at the quarry.

Most flatbed trucks will carry 22-24 tons of stone. If the truck is to cross state boundaries, it will carry less to make sure that they are not overweight. It is required by state law that the loaded truck must be tarped when crossing state boundaries. The customer is responsible for arranging to have a machine at the delivery site to off-load the truck.

Quality Stone can deliver loads in bulk within Texas. We have dump trucks that can carry up to 13 tons for smaller deliveries and truck & pup trailers that can carry up to 25 tons. We also have a 22-23 ton flatbed for local deliveries and the customer must have a machine to off-load the pallets.

Another option we have for smaller quantities is to hire a truck for less than 5 tons in bulk or less than 10 tons on pallets. We have a local company that makes these deliveries for us. They have a machine for off-loading pallets on the flatbed, for an additional fee. The operator will place the stone on the ground, but does not place the stone in its final resting place. Arrangements might be made with the operator to place the pallets in a specific place, for an additional fee, if the arrangements are agreed upon in advance.

***When an outside flatbed or LTL carrier is hired to deliver your stone, you must inspect the delivery BEFORE signing the freight bill. Once the bill is signed and you find broken stone, you have no claim. It is critical to take pictures and log any problems on the freight bill before signing.*

Weather

There may be occasions when, due to the weather, we will be unable to deliver on the selected date. You will need to verify that your property is dry enough to handle the weight of a 12 or 24 ton truck or we will reschedule delivery to a better time and day. If by some chance a truck breaks down, we may need to reschedule your delivery. Generally we call between 7-8 am, for a morning delivery, on the day of your delivery to reconfirm conditions and the timing of delivery.

Terrain

Most machines and trucks must operate on level ground. If the truck and/or machine are not level, the operator may not be able to off-load at that location. Safety must be observed at all times. The truck and machine may have to move to a better area to off-load.

For all dump trucks loads of stone, the customer must be aware of the terrain and obstacles that are in the area where you want the truck to dump. The dump truck bed will rise up about 12 feet in the air (end dumps are twice that) so power lines, trees and anything else that may hinder or endanger the truck must be avoided. A truck is about 12 feet wide, so there must be clearance on each side. A firm level surface must be provided for the stability of the off-loading. If the ground is soft the truck may sink and/or turn over. This may also damage a septic tank if the truck drives over it and sinks.

The truck may also leave ruts in your yard if the ground is soft. The customer is responsible for having the truck towed if it gets stuck. The driver may have you sign a release if he feels that conditions are not ideal for dumping or off-loading in the particular area you have chosen.

Flatbeds also need a firm level surface so that the machine operator can off-load the pallets with no obstructions, safety issues and with confidence. Being aware of safety hazards and requirements prior to delivery will allow you to choose the best place for your delivery to be dumped or off-loaded. Discuss anything in question with your delivery driver.

Knowing the facts about your delivery and packaging will make your experience with your stone purchase rewarding and successful.





FIND US

3450 FM 2843
Florence, Texas 76527

P | 254.793.3791
E | info@qualitystone.com

CONNECT WITH US



QUALITYSTONE.COM